

STANDARD Precision Balances

Compact and mobile solution.



WTC, d = 0.001 g













WTC: d = 0.01 g, d = 0.1 g



Communication interfaces

Functions

- | | | | | |
|---|--|--|---|--|
|  Parts counting |  Percent weighing |  Totalizing |  In-built battery |  Replaceable unit |
|  +/- Control |  Peak hold |  Alibi memory |  Real-time clock |  Tare memory |

Features

Measurements Accuracy and Performance

Measurement accuracy and robust design of the WTC balances enable precise mass determination under laboratory and industrial conditions.

Fast Measurement and Uncomplicated Operation

Easy operation enables fast and reliable measurements to be carried out even by an inexperienced operator.

Clearly Presented Indications

Simple and easy-to-read LCD display assures clear presentation of the weighing result under various working conditions.

Mobility Due to an Internal Battery

In addition to power supply from the mains, the WLC balances are equipped with an external battery that enables several hours long mobile operation.

Compact Mechanical Design

Small size and compact design enable easy transport of the balance and operation at any workplace, even on a small surface.

	WTC 200	WTC 600	WTC 2000	WTC 3000
Maximum capacity [Max]	200 g	600 g	2000 g	3100 g
Minimum load	—	0.5 g	—	—
Readability [d]	0.001 g	0.01 g	0.01 g	0.1 g
Verification scale interval [e]	—	0.1 g	—	—
Tare range	-200 g	-600 g	-2000 g	-3100 g
Repeatability*	0.002 g	0.01 g	0.01 g	0.1 g
Linearity	±0.004 g	±0.02 g	±0.03 g	±0.3 g
Stabilization time	2 s	2 s	2 s	2 s
Adjustment	external	—	external	external
Verification	—	Yes	—	—
OIML Class	—	II	—	—
Display	LCD (with backlight)	LCD (with backlight)	LCD (with backlight)	LCD (with backlight)
Keypad	5 keys	5 keys	5 keys	5 keys
Protection class	IP 43	IP 43	IP 43	IP 43
USB-A	1	—	1	1
USB-B	1	—	1	1
RS 232	1	1	1	1
Wi-Fi® **	802.11 b/g/n	802.11 b/g/n	802.11 b/g/n	802.11 b/g/n
Power supply	100 ÷ 240 V, AC 50 ÷ 60 Hz / 12 V DC + battery	100 ÷ 240 V, AC 50 ÷ 60 Hz / 12 V DC + battery	100 ÷ 240 V, AC 50 ÷ 60 Hz / 12 V DC + battery	100 ÷ 240 V, AC 50 ÷ 60 Hz / 12 V DC + battery
Operation time on batteries	15 h	15 h	15 h	15 h
Power consumption	6 W	6 W	6 W	6 W
Operating temperature	+15° ÷ +30° C	+15° ÷ +30° C	+15° ÷ +30° C	+15° ÷ +30° C
Atmospheric humidity**	40 ÷ 80 %	40 ÷ 80 %	40 ÷ 80 %	40 ÷ 80 %
Weighing pan dimensions	∅ 100	128 × 128 mm	128 × 128 mm	128 × 128 mm
Weighing device dimensions	230 × 160 × 68 mm	230 × 160 × 68 mm	230 × 160 × 68 mm	230 × 160 × 68 mm
Net weight	1.2 kg	1.3 kg	1.3 kg	1.3 kg
Gross weight	1.7 kg	2 kg	2 kg	2 kg
Packaging dimensions	330 × 220 × 140 mm	330 × 220 × 140 mm	330 × 220 × 140 mm	330 × 220 × 140 mm

* repeatability is expressed as a standard deviation from 10 weighing cycles

** optional solution on purchase order

*** non-condensing conditions

In accordance with type approval, the balance parameters are maintained in temperature range: +15 ÷ +35 °C.

Dimensions

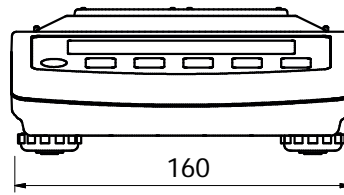
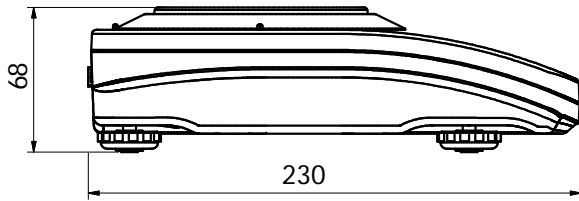

WTC, d = 0.001 g

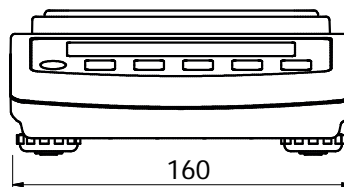
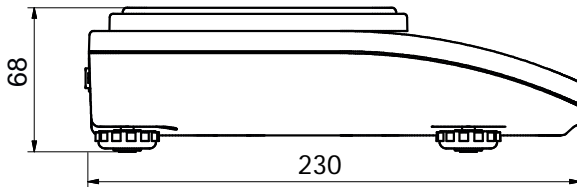

WTC: d = 0.01 g, d = 0.1 g

Accessories

Cables. Converters

- P0108: RS 232 cable (balance-computer)
- P0151: RS 232 cable (balance - Epson printer)
- KR-01 Converter
- AP2-1 power loop output

Peripheral Devices

- Epson dot matrix printer

Dedicated Software

R-LAB

- collecting measurements
- carrying out statistical analysis of measurements
- customized graphs and reports

LabView Driver

- operation of RADWAG balances in LabView environment

Scale editor

- Software designed to enable change of parameters in the PUEC/31 indicator.

RAD KEY

- Establishing cooperation between a weighing instrument and a computer

R. Barcode

- The basic function software is presentation of the data sent by barcode scanners connected to PC via USB or RS232

Radwag Development Studio

- presentation of functions (and subfunctions) of communication protocol (Common Communication Protocol)
- possibility of connection with weighing equipment on which each function is carried out,
- library with mass control, contained within the development environment
- complete documentation of the communication protocol
- set of user manuals for different solutions addressed for programmers employed in companies using RADWAG-manufactured weighing equipment

RADWAG Connect

- establishing communication with all balances, scales and weighing modules using Common Communication Protocol
- communication via local network,
- support of basic functions
- auto searching for devices
- connecting with few devices simultaneously, swapping between them
- clear list of connected platforms
- record of measurements in the program,
- export of carried out measurements to CSV file,
- work performed using freely selected device with Windows 10 operating system

Rugged Precision Balances

'Standard level' measurement and proper protection class intended for operation under challenging conditions



PS R2.H, d = 1 mg



PS R2.M.H, d = 10 mg

















Hermetic external interface



Interface separated from the balance

Functions

- | | | | | |
|---|--|---|---|---|
|  Parts counting |  Percent weighing |  Autotest |  Peak hold |  Alibi memory |
|  Dosing |  Statistics |  Density determination |  GLP procedures |  Replaceable unit |
|  Checkweighing |  Animal weighing |  Under hook weighing |  Ambient conditions measurement |  Multilingual menu |

Features

Ease of Use and Measurements Accuracy

Combination of weighing accuracy and robust design enables applying PS R2.H balances in most of the laboratory and industrial solutions.

Resistance and Protection Under Unfavourable Ambient Conditions

The design of appropriate protection class and closing the communication interfaces in a separate hermetic housing enable operation under difficult conditions (water splash, dust, etc.).

Perfect Readability and Clear Information Layout

Large, easy-to-read LCD display offers not only a clear presentation of the weighing result, but also enables displaying messages related to the drying process as well as pictograms of active functions and working modes.

Quick Access to Selected Functions

Quick access keys located on the operation panel enable you to run a given function with just one click. You can assign some of the keys with a function of your choice.

Automatic Adjustment

Internal adjustment system guarantees the highest accuracy and reliable measurements results.

RADWAG MonoBLOCK™, an Innovative Weighing System

The most advanced weighing system technology allowing measurement with the readability of $d=0.01$ g at 10 kg maximum capacity. The mechanism guarantees stable repeatability over the whole product life cycle, it also ensures high resistance to ambient conditions change.

Data Management

PS R2.H information system is based on operators, products, weighings and tares databases. All saved data can be analysed, exported, imported or exchanged between weighing instruments.

ALIBI Memory

Internal ALIBI memory guarantees safety and automatic record of measurements copies, it also offers possibility to preview, copy and archive data.

	PS 200/2000.R2.H	PS 210.R2.H	PS 360.R2.H	PS 600.R2.H
Maximum capacity [Max]	200 g / 2000 g	210 g	360 g	600 g
Minimum load	0.02 g	0.02 g	0.02 g	0.02 g
Readability [d]	0.001 g / 0.01 g	0.001 g	0.001 g	0.001 g
Verification scale interval [e]	—	—	—	—
Tare range	-2000 g	-210 g	-360 g	-600 g
Repeatability (5% Max)*	0.0005 / 0.005 g	0.0005 g	0.0005 g	0.0005 g
Repeatability (Max)	0.001 / 0.01 g	0.001 g	0.001 g	0.0015 g
Linearity	±0.002 g / ±0.02 g	±0.002 g	±0.002 g	±0.003 g
Sensitivity temperature drift**	2 × 10 ⁻⁶ / °C × Rt	2 × 10 ⁻⁶ / °C × Rt	2 × 10 ⁻⁶ / °C × Rt	2 × 10 ⁻⁶ / °C × Rt
Minimum weight (U=1%, k=2)	0.1 g	0.1 g	0.1 g	0.1 g
Minimum weight (USP)	1 g	1 g	1 g	1 g
Stabilization time	2 s / 1.5 s	2 s	2 s	2 s
Adjustment	internal	internal	internal	internal
Verification	—	—	—	—
OIML Class	—	—	—	—
Display	LCD (with backlight)	LCD (with backlight)	LCD (with backlight)	LCD (with backlight)
Keypad	14 keys	14 keys	14 keys	14 keys
Protection class	IP 54	IP 54	IP 54	IP 54
Databases	5	5	5	5
USB-A	1	1	1	1
USB-B	1	1	1	1
RS 232	2	2	2	2
Wi-Fi® ***	802.11 b/g/n	802.11 b/g/n	802.11 b/g/n	802.11 b/g/n
Power supply	12 ÷ 16 V DC	12 ÷ 16 V DC	12 ÷ 16 V DC	12 ÷ 16 V DC
Power consumption	4 W	4 W	4 W	4 W
Operating temperature	+10 ÷ +40 °C	+10 ÷ +40 °C	+10 ÷ +40 °C	+10 ÷ +40 °C
Atmospheric humidity****	40 ÷ 80%	40 ÷ 80%	40 ÷ 80%	40 ÷ 80%
Transport and storage temperature	-20 ÷ +50 °C	-20 ÷ +50 °C	-20 ÷ +50 °C	-20 ÷ +50 °C
Weighing pan dimensions	ø 115 mm	ø 115 mm	ø 115 mm	ø 115 mm
Weighing pan material	stainless steel 0H18N9	stainless steel 0H18N9	stainless steel 0H18N9	stainless steel 0H18N9
Weighing device dimensions	333 × 206 × 166 mm	333 × 206 × 166 mm	333 × 206 × 166 mm	333 × 206 × 166 mm
Net weight	4.5 kg	4.2 kg	4.2 kg	4.3 kg
Gross weight	6.5 kg	6.2 kg	6.2 kg	6.3 kg
Packaging dimensions	470 × 380 × 336 mm	470 × 380 × 336 mm	470 × 380 × 336 mm	470 × 380 × 336 mm

Rt net weight

* repeatability is expressed as a standard deviation from 10 weighing cycles

** parameter determined in the following temperature range: +15 ÷ +35 °C

*** optional solution on purchase order

**** non-condensing conditions

In accordance with type approval, the balance parameters are maintained in temperature range: +15 ÷ +35 °C.

Wi-Fi® is a registered trademark of Wi-Fi® Alliance.

	PS 750.R2.H	PS 1000.R2.H	PS 2100.R2.M.H	PS 3500.R2.M.H
Maximum capacity [Max]	750 g	1000 g	2100 g	3500 g
Minimum load	0.02 g	0.02 g	0.5 g	0.5 g
Readability [d]	0.001 g	0.001 g	0.01 g	0.01 g
Verification scale interval [e]	—	—	—	—
Tare range	-750 g	-1000 g	-2100 g	-3500 g
Repeatability (5% Max)*	0.0005 g	0.0005 g	0.005 g	0.005 g
Repeatability (Max)	0.0015 g	0.0015 g	0.008 g	0.008 g
Linearity	±0.003 g	±0.003 g	±0.02 g	±0.02 g
Sensitivity temperature drift**	$2 \times 10^{-6} / ^\circ\text{C} \times R_t$	$2 \times 10^{-6} / ^\circ\text{C} \times R_t$	$2 \times 10^{-6} / ^\circ\text{C} \times R_t$	$2 \times 10^{-6} / ^\circ\text{C} \times R_t$
Minimum weight (U=1%, k=2)	0.1 g	0.1 g	1 g	1 g
Minimum weight (USP)	1 g	1 g	10 g	10 g
Stabilization time	2 s	2 s	1.5 s	1.5 s
Adjustment	internal	internal	internal	internal
Verification	—	—	—	—
OIML Class	—	—	—	—
Display	LCD (with backlight)	LCD (with backlight)	LCD (with backlight)	LCD (with backlight)
Keypad	14 keys	14 keys	14 keys	14 keys
Protection class	IP 54	IP 54	IP 54	IP 54
Databases	5	5	5	5
USB-A	1	1	1	1
USB-B	1	1	1	1
RS 232	2	2	2	2
Wi-Fi® ***	802.11 b/g/n	802.11 b/g/n	802.11 b/g/n	802.11 b/g/n
Power supply	12 ÷ 16 V DC	12 ÷ 16 V DC	12 ÷ 16 V DC	12 ÷ 16 V DC
Power consumption	4 W	4 W	4 W	4 W
Operating temperature	+10 ÷ +40 °C	+10 ÷ +40 °C	+10 ÷ +40 °C	+10 ÷ +40 °C
Atmospheric humidity****	40 ÷ 80%	40 ÷ 80%	40 ÷ 80%	40 ÷ 80%
Transport and storage temperature	-20 ÷ +50 °C	-20 ÷ +50 °C	-20 ÷ +50 °C	-20 ÷ +50 °C
Weighing pan dimensions	ø 115 mm	ø 115 mm	195 × 195 mm	195 × 195 mm
Weighing pan material	stainless steel 0H18N9	stainless steel 0H18N9	stainless steel 0H18N9	stainless steel 0H18N9
Weighing device dimensions	333 × 206 × 166 mm	333 × 206 × 166 mm	333 × 206 × 100 mm	333 × 206 × 100 mm
Net weight	4.3 kg	4.5 kg	4.3 kg	4.5 kg
Gross weight	6.3 kg	6.5 kg	5.8 kg	6 kg
Packaging dimensions	470 × 380 × 336 mm	470 × 380 × 336 mm	470 × 380 × 336 mm	470 × 380 × 336 mm

Rt net weight

* repeatability is expressed as a standard deviation from 10 weighing cycles

** parameter determined in the following temperature range: +15 ÷ +35 °C

*** optional solution on purchase order

**** non-condensing conditions

In accordance with type approval, the balance parameters are maintained in temperature range: +15 ÷ +35 °C.

Wi-Fi® is a registered trademark of Wi-Fi® Alliance.

	PS 4500.R2.M.H	PS 6100.R2.M.H
Maximum capacity [Max]	4500 g	6100 g
Minimum load	0.5 g	0.5 g
Readability [d]	0.01 g	0,01 g
Verification scale interval [e]	—	—
Tare range	-4500 g	-6100 g
Repeatability (5% Max)*	0.005 g	0.005 g
Repeatability (Max)	0.008 g	0.008 g
Linearity	±0.03 g	±0.03 g
Sensitivity temperature drift**	$2 \times 10^{-6} / ^\circ\text{C} \times R_t$	$2 \times 10^{-6} / ^\circ\text{C} \times R_t$
Minimum weight (U=1%, k=2)	1 g	1 g
Minimum weight (USP)	10 g	10 g
Stabilization time	1.5 s	1.5 s
Adjustment	internal	internal
Verification	—	—
OIML Class	—	—
Display	LCD (with backlight)	LCD (with backlight)
Keypad	14 keys	14 keys
Protection class	IP 54	IP 54
Databases	5	5
USB-A	1	1
USB-B	1	1
RS 232	2	2
Wi-Fi® ***	802.11 b/g/n	802.11 b/g/n
Power supply	12 ÷ 16 V DC	12 ÷ 16 V DC
Power consumption	4 W	4 W
Operating temperature	+10 ÷ +40 °C	+10 ÷ +40 °C
Atmospheric humidity****	40 ÷ 80%	40 ÷ 80%
Transport and storage temperature	-20 ÷ +50 °C	-20 ÷ +50 °C
Weighing pan dimensions	195 × 195 mm	195 × 195 mm
Weighing pan material	stainless steel 0H18N9	stainless steel 0H18N9
Weighing device dimensions	333 × 206 × 107 mm	333 × 206 × 107 mm
Net weight	4.5 kg	4.5 kg
Gross weight	6.1 kg	6.1 kg
Packaging dimensions	470 × 380 × 336 mm	470 × 380 × 336 mm

- Rt net weight
- * repeatability is expressed as a standard deviation from 10 weighing cycles
- ** parameter determined in the following temperature range: +15 ÷ +35 °C
- *** optional solution on purchase order
- **** non-condensing conditions

In accordance with type approval, the balance parameters are maintained in temperature range: +15 ÷ +35 °C.

Wi-Fi® is a registered trademark of Wi-Fi® Alliance.

Dimensions

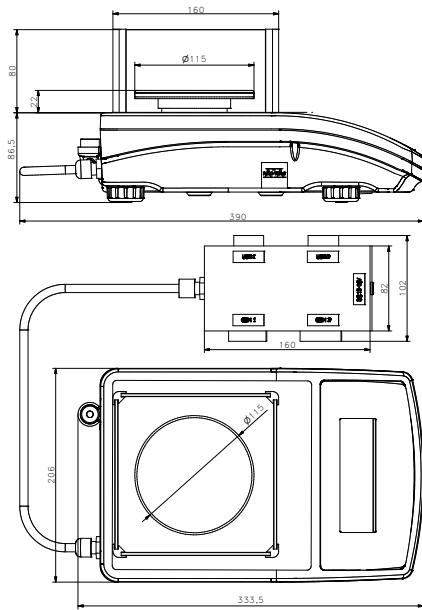

PS R2.H, d = 1 mg

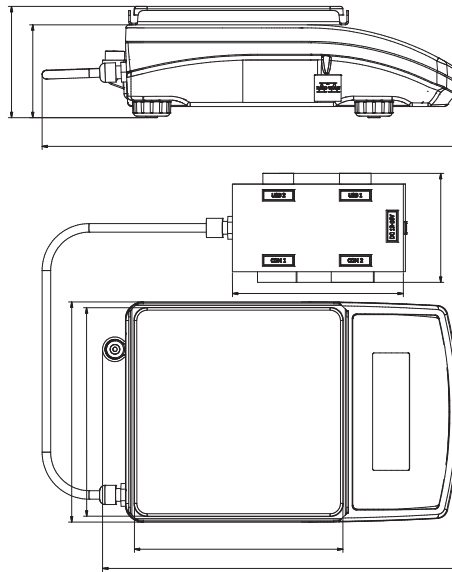

PS R2.M.H, d = 10 mg

Accessories

Weighing Tables

- granite antivibration table
- antivibration tables for laboratory balances
- professional weighing table

Professional Weighing

- KIT 195 density determination kit
- under-hook weighing rack

Peripheral Devices

- label printer
- receipt printer
- Epson dot matrix printer
- barcode scanners
- WD-6 LCD display

Cables, Converters

- P0108: RS 232 cable (balance-computer)
- P0151: RS 232 cable (balance - Epson printer)
- USB cable type A-B
- AP2-1 power loop output

Electrical Accessories

- power supply with ZR-02 battery

Remaining Accessories

- panel box

Dedicated Software

R-LAB

- collecting measurements
- carrying out statistical analysis of measurements
- customized graphs and reports

E2R Weighing Records

- complete, automated databases synchronization
- fully supported processes of labelling and parts counting
- record of weighings, weighings archiving
- basic and advanced (with graphs) reports

RAD KEY

- Establishing cooperation between a weighing instrument and a computer

R.Barcode

- The basic function software is presentation of the data sent by barcode scanners connected to PC via USB or RS232

Radwag Development Studio

- presentation of functions (and subfunctions) of communication protocol (Common Communication Protocol)
- possibility of connection with weighing equipment on which each function is carried out,
- library with mass control, contained within the development environment
- complete documentation of the communication protocol
- set of user manuals for different solutions addressed for programmers employed in companies using RADWAG-manufactured weighing equipment

LabView Driver

- operation of RADWAG balances in LabView environment

RADWAG Connect

- establishing communication with all balances, scales and weighing modules using Common Communication Protocol
- communication via local network,
- support of basic functions
- auto searching for devices
- connecting with few devices simultaneously, swapping between them
- clear list of connected platforms
- record of measurements in the program,
- export of carried out measurements to CSV file,
- work performed using freely selected device with Windows 10 operating system

Alibi Reader

- readout of data saved to Alibi memory
- export of data saved to Alibi memory
- data filtering and reports generating
- saving ALIBI database to CSV file

R Panel

- operator access to all keys and functions that are to be found on an operation panel
- communication via COM1, COM2 or USB,
- compatible with: Windows Vista, 7, 8, 8.1, 10, Server 2008R2, 2012, 2016.



QAQC LAB

www.qclabequipment.com

Advanced Precision Balances

'Advanced level' measurement of large masses with the highest accuracy in laboratory and industry



PM C32, d = 0.01 g

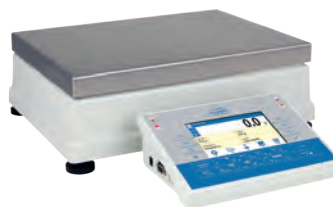

PM C32, d = 0.1 g



Radwag MonoBLOCK™, an innovative weighing system



PM C32: d = 0.5 g, d = 1 g



Weighing heavy loads with the maximum accuracy

Functions



Parts counting



Percent weighing



Under hook weighing



Proximity sensors



Alibi memory



Checkweighing



Statistics



GLP procedures

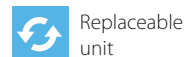

Replaceable unit



Multilingual menu

Technical Specifications

Reliable Results and High Measurement Precision

Excellent measurement parameters and performance enable applying PM C32 balances in laboratories and various branches of industry.

Radwag MonoBLOCK™, an Innovative Weighing System

The cutting edge technology of the measuring system guarantees stability of repeatability in time, where $sd < 1$, and a significant resistance to ambient conditions.

Weighing Heavy Loads With the Maximum Accuracy

It is possible to work with samples of different weight values, from few grams to several kilograms, wherein the highest measurement accuracy and excellent result repeatability are maintained.

Reliability and Safety

4-point protection system prevents balance overloading, this ensures safety in case too heavy load is applied onto the weighing pan. Robust design allows to operate the device even in the most challenging ambient conditions.

Ease of Use and Maximum Comfort of Operation

5" colour screen enables intuitive operation and easy access to numerous applications and functions. PM C32 program allows screen layout customization.

Automatic Adjustment

Internal adjustment system guarantees the highest accuracy and reliable measurements results.

Touch-Free Operation

Two programmable proximity sensors can be assigned with any function or application. The given function when assigned is both run and operated touch-free.

Numerous Options of Data Management

The instrument enables saving all completed measurements data as complex reports and graphs.

	PM 10.C32	PM 15.C32	PM 25.C32	PM 35.C32
Maximum capacity [Max]	10 kg	15 kg	25 kg	35 kg
Preload	1 kg	1.5 kg	2.5 kg	3.5 kg
Minimum load	0.5 g	0.5 g	5 g	5 g
Readability [d]	0.01 g	0.01 g	0.1 g	0.1 g
Verification scale interval [e]	0.1 g	—	1 g	1 g
Tare range	-10 kg	-15 kg	-25 kg	-35 kg
Repeatability (5% Max)*	0.004 g	0.004 g	0.04 g	0.04 g
Repeatability (Max)	0.01 g	0.015 g	0.1 g	0.1 g
Linearity	± 0.03 g	± 0.03 g	± 0.3 g	± 0.3 g
Sensitivity temperature drift**	$2 \times 10^{-6} / ^\circ\text{C} \times \text{Rt}$	$2 \times 10^{-6} / ^\circ\text{C} \times \text{Rt}$	$2 \times 10^{-6} / ^\circ\text{C} \times \text{Rt}$	$2 \times 10^{-6} / ^\circ\text{C} \times \text{Rt}$
Minimum weight (U=1%, k=2)	0.82 g	0.82 g	8.2 g	8.2 g
Minimum weight (USP)	8.2 g	8.2 g	82 g	82 g
Stabilization time	3 s	3 s	3 s	3 s
Adjustment	internal	internal	internal	internal
Verification	Yes	—	Yes	Yes
OIML Class	II	—	II	II
Indicator fastening	1.5 m cable	1.5 m cable	1.5 m cable	1.5 m cable
Terminal model	PUE C32 indicator	PUE C32 indicator	PUE C32 indicator	PUE C32 indicator
Display	5" graphic colour	5" graphic colour	5" graphic colour	5" graphic colour
Keypad	22-key membrane	22-key membrane	22-key membrane	22-key membrane
Protection class	IP 43	IP 43	IP 43	IP 43
Databases	5	5	5	5
Touch-free operation	2 programmable proximity sensors	2 programmable proximity sensors	2 programmable proximity sensors	2 programmable proximity sensors
USB-A	1	1	1	1
USB-B	1	1	1	1
RS 232	2	2	2	2
Ethernet	10 / 100 Mbit	10 / 100 Mbit	10 / 100 Mbit	10 / 100 Mbit
Wi-Fi®	802.11 b/g/n	802.11 b/g/n	802.11 b/g/n	802.11 b/g/n
Power supply	12 ÷ 16 V DC	12 ÷ 16 V DC	12 ÷ 16 V DC	12 ÷ 16 V DC
Power consumption	15 W	15 W	15 W	15 W
Operating temperature	+10 ÷ +40 °C	+10 ÷ +40 °C	+10 ÷ +40 °C	+10 ÷ +40 °C
Atmospheric humidity***	40 ÷ 80 %	40 ÷ 80 %	40 ÷ 80 %	40 ÷ 80 %
Transport and storage temperature	-10 ÷ +50 °C	-10 ÷ +50 °C	-10 ÷ +50 °C	-10 ÷ +50 °C
Weighing pan dimensions	200 × 185 mm	200 × 185 mm	347 × 259 mm	347 × 259 mm
Weighing device dimensions	508 × 296 × 115 mm	508 × 296 × 115 mm	508 × 296 × 115 mm	508 × 296 × 115 mm
Net weight	10 kg	10 kg	11 kg	11 kg
Gross weight	12.2 kg	12.2 kg	13.2 kg	13.2 kg
Packaging dimensions	520 × 520 × 280 mm	520 × 520 × 280 mm	520 × 520 × 280 mm	520 × 520 × 280 mm

Rt net weight

* repeatability is expressed as a standard deviation from 10 weighing cycles

** parameter determined in the following temperature range: +15 ÷ +35 °C

*** non-condensing conditions

In accordance with type approval, the balance parameters are maintained in temperature range: +15 ÷ +35 °C.

Wi-Fi® is a registered trademark of Wi-Fi® Alliance.

	PM 50.C32	PM 60.05.C32	PM 60.1.C32
Maximum capacity [Max]	50 kg	60 kg	60 kg
Preload	5 kg	—	—
Minimum load	5 g	0.5 g	1 g
Readability [d]	0.1 g	0.5 g	1 g
Verification scale interval [e]	1 g	—	—
Tare range	-50 kg	-60 kg	-60 kg
Repeatability (5% Max)*	0.04 g	0.2 g	0.4 g
Repeatability (Max)	0.15 g	0.4 g	0.8 g
Linearity	± 0.3 g	± 1.5 g	± 3 g
Sensitivity temperature drift**	$2 \times 10^{-6} / ^\circ\text{C} \times \text{Rt}$	$2 \times 10^{-6} / ^\circ\text{C} \times \text{Rt}$	$2 \times 10^{-6} / ^\circ\text{C} \times \text{Rt}$
Minimum weight (U=1%, k=2)	8.2 g	41 g	82 g
Minimum weight (USP)	82 g	410 g	820 g
Stabilization time	3 s	3 s	3 s
Adjustment	internal	internal	internal
Verification	Yes	—	—
OIML Class	II	—	—
Indicator fastening	1.5 m cable	1.5 m cable	1.5 m cable
Terminal model	PUE C32 indicator	PUE C32 indicator	PUE C32 indicator
Display	5" graphic colour	5" graphic colour	5" graphic colour
Keypad	22-key membrane	22-key membrane	22-key membrane
Protection class	IP 43	IP 43	IP 43
Databases	5	5	5
Touch-free operation	2 programmable proximity sensors	2 programmable proximity sensors	2 programmable proximity sensors
USB-A	1	1	1
USB-B	1	1	1
RS 232	2	2	2
Ethernet	10 / 100 Mbit	10 / 100 Mbit	10 / 100 Mbit
Wi-Fi®	802.11 b/g/n	802.11 b/g/n	802.11 b/g/n
Power supply	12 ÷ 16 V DC	12 ÷ 16 V DC	12 ÷ 16 V DC
Power consumption	15 W	15 W	15 W
Operating temperature	+10 ÷ +40 °C	+10 ÷ +40 °C	+10 ÷ +40 °C
Atmospheric humidity***	40 ÷ 80 %	40 ÷ 80 %	40 ÷ 80 %
Transport and storage temperature	-10 ÷ +50 °C	-10 ÷ +50 °C	-10 ÷ +50 °C
Weighing pan dimensions	347 × 260 mm	500 × 400 mm	500 × 400 mm
Weighing device dimensions	508 × 296 × 115 mm	640 × 400 × 115 mm	640 × 400 × 115 mm
Net weight	11 kg	17 kg	17 kg
Gross weight	13.2 kg	19 kg	19 kg
Packaging dimensions	520 × 520 × 280 mm	700 × 600 × 200 mm	700 × 600 × 200 mm

Rt net weight

* repeatability is expressed as a standard deviation from 10 weighing cycles

** parameter determined in the following temperature range: +15 ÷ +35 °C

*** non-condensing conditions

In accordance with type approval, the balance parameters are maintained in temperature range: +15 ÷ +35 °C.

Wi-Fi® is a registered trademark of Wi-Fi® Alliance.

Dimensions

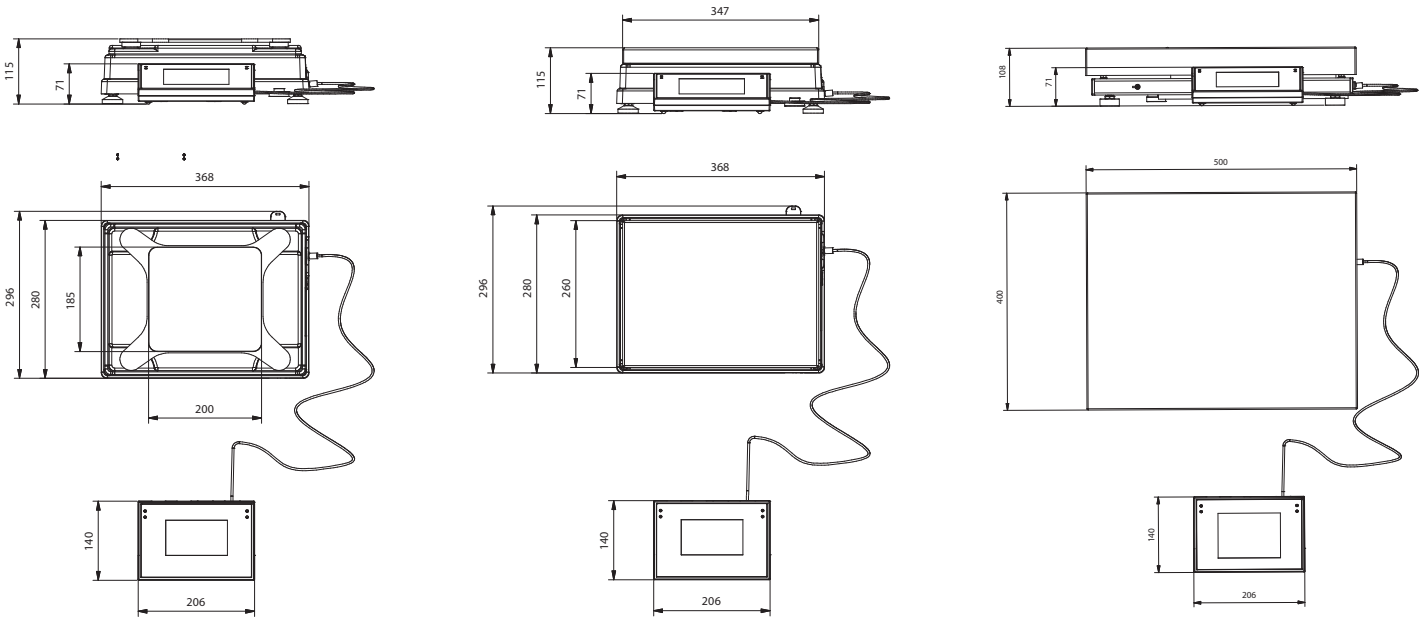

PM C32, d = 0.01 g

PM C32, d = 0.1 g

PM C32: d = 0.5 g, d = 1 g

Accessories

Weighing Tables

- granite antivibration table
- antivibration tables for laboratory balances

Peripheral Devices

- Epson dot matrix printer
- barcode scanners
- WD-6 LCD display

Electrical accessories

- ZR-02 power supply with battery

Cables, Converters

- P0108: RS 232 cable (balance-computer)
- P0167: RS 232 cable (balance-computer)
- P0151: RS 232 cable (balance - Epson printer)
- AP2-1 power loop output
- IN/OUT cables

Draft shields and anti-draft chambers

- storage case for PM 10 kg, PM 15 kg, PM 35 kg, PM 50kg, PM.KB balances

Dedicated Software

R-LAB

- collecting measurements
- carrying out statistical analysis of measurements
- customized graphs and reports

E2R Weighing Records

- complete, automated databases synchronization
- fully supported processes of labelling and parts counting
- record of weighings, weighings archiving
- basic and advanced (with graphs) reports

Alibi Reader

- readout of data saved to Alibi memory
- export of data saved to Alibi memory
- data filtering and reports generating
- saving ALIBI database to CSV file

R.Barcode

- The basic function software is presentation of the data sent by barcode scanners connected to PC via USB or RS232

RAD KEY

- Establishing cooperation between a weighing instrument and a computer

Radwag Development Studio

- presentation of functions (and subfunctions) of communication protocol (Common Communication Protocol)
- possibility of connection with weighing equipment on which each

function is carried out,

- library with mass control, contained within the development environment
- complete documentation of the communication protocol
- set of user manuals for different solutions addressed for programmers employed in companies using RADWAG-manufactured weighing equipment

RADWAG Connect

- establishing communication with all balances, scales and weighing modules using Common Communication Protocol
- communication via local network,
- support of basic functions
- auto searching for devices
- connecting with few devices simultaneously, swapping between them
- clear list of connected platforms
- record of measurements in the program,
- export of carried out measurements to CSV file,
- work performed using freely selected device with Windows 10 operating system

LabView Driver

- operation of RADWAG balances in LabView environment