

Product Specification

Specification Number 675 A92650

Revision 01

Part No.	675 A92650
Description	Toggle Drum 50L
Materials of Construction:	<ul style="list-style-type: none"> - Body: 316 stainless steel - Lid: 316 stainless steel - Toggles: 304 stainless steel - Handles: 304 stainless steel - Gasket: Silicone (FDA 177.2600 and USP Class VI compliant)

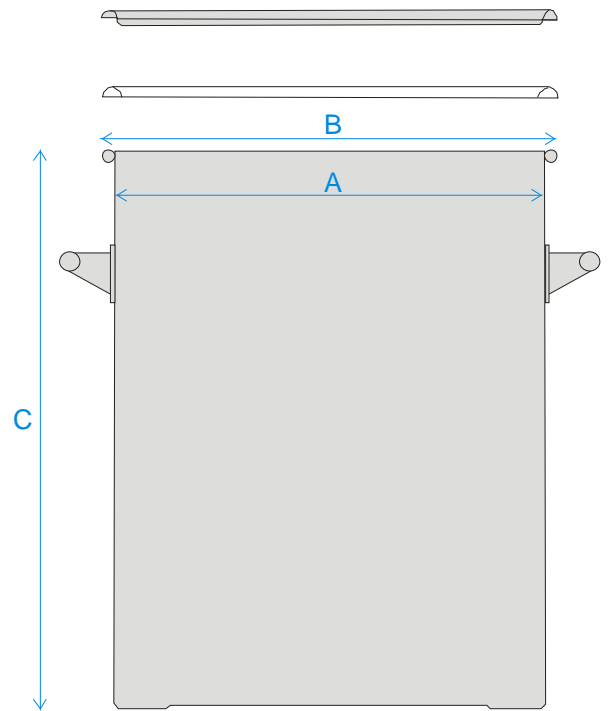

Nominal Volume:	50 Litres
Brimful Volume:	52 Litres
Method of Construction:	Welds ground and polished
Surface Finish:	Better than 0.5 microns Ra
Dimensions	<p>A = 395 mm</p> <p>B = 415 mm</p> <p>C = 430 mm</p>
Graduation Marks:	None
Handles:	2 side handles welded onto patch plates
Number of Toggles:	4
Weight:	8.7Kg (body + gasket + lid)