

Product Specification

Specification Number

675 A19610

Revision

01

Part No.

675 A19610

Description

Stainless Storage Drum 10L with 1" Ferrule

Materials of Construction:

- Body: 316L stainless steel
- Ferrule: 316L stainless steel
- Lid: 316L stainless steel
- Clamp: 304 stainless steel
- Handles: 304 stainless steel
- Gasket: Silicone (FDA 177.2600 and USP Class VI compliant)

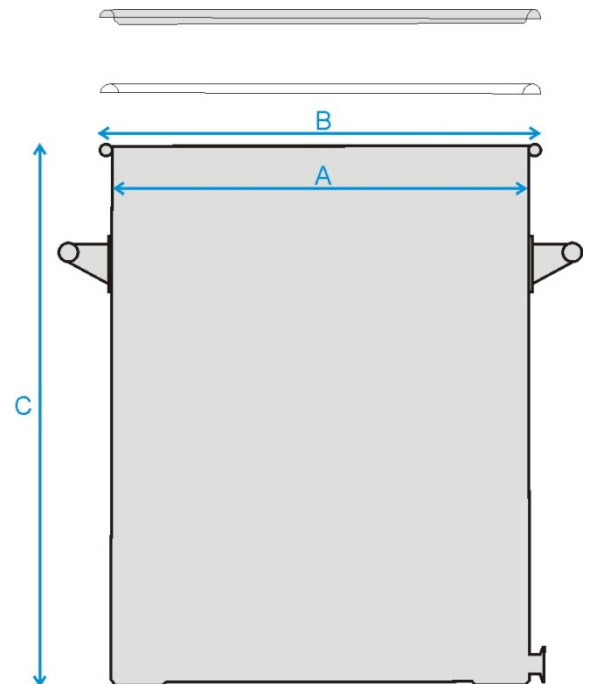

Nominal Volume:

10 Litres

Method of Construction:

Welds ground and polished

Surface Finish:

Better than 0.5 microns Ra

Dimensions

A = 230 mm
B = 250 mm
C = 270 mm

Graduation Marks:

None

Ferrule:

1" (to standard BS4825-3)

Ferrule location

25mm from base to underside of ferrule

Handles:

2 side handles welded onto patch plates

Weight:

3.65 Kg (body + gasket + lid + clamp)