

Product Specification

Specification Number 675 A12605

Revision 03

Part No. 675 A12605

Description Stainless Storage Drum 5L

Materials of Construction:

- Body: 316L stainless steel
- Lid: 316L stainless steel
- Clamp: 304 stainless steel
- Handles: 304 stainless steel
- Gasket: Silicone (FDA 177.2600 and USP Class VI compliant)

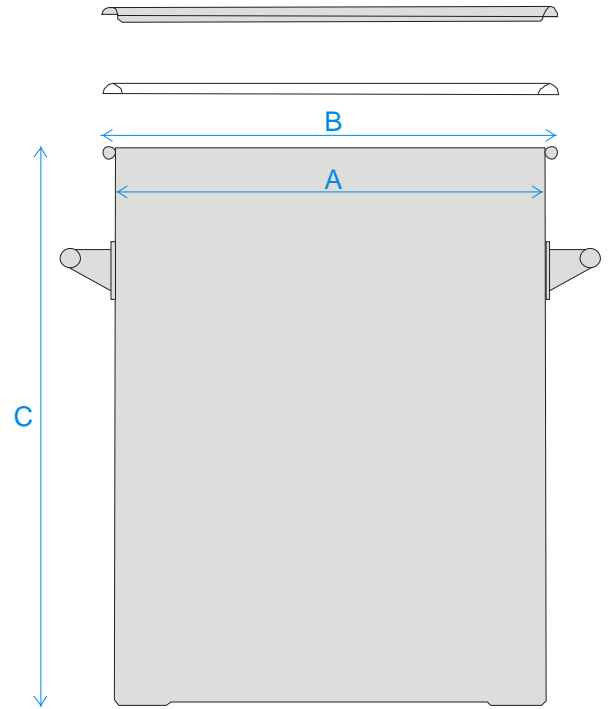

Nominal Volume: 5 Litres

Method of Construction: Welds ground and polished

Surface Finish: Better than 0.5 microns Ra

Dimensions
A = 196 mm
B = 216 mm
C = 200 mm

Graduation Marks: None

Handles: 2 side handles welded onto patch plates

Weight: 2.70 Kg (body + gasket + lid + clamp)