



WHEN PARTICLE SIZE MATTERS



QAQC LAB

www.qclabequipment.com

1. Technical specifications

7. Operating instructions: EFL 300



Technical specifications

SIEVE SHAKER MODEL: EFL 300

General Information

The new EFL 300 combines the best features of the EFL2 whilst incorporating modern sieve shaker technology. It is still extremely robust but lightweight and more powerful than its predecessor. Heavier and larger samples can be sieved with the new EFL 300.

It is extremely versatile. **Amplitude setting is now standard and interval mode possible.** The heavy electric motor is replaced by the electromagnetic system found in all modern sieve shakers. Its lighter form means that it can be either floor standing or even bench mounted making it suitable for the both laboratory and industrial environments. Sieving parameters are set by the remote control unit. Its functions are logical and very simple to operate.

Advantages

- New electromagnetic drive for EFL 300
- Adjustable amplitude
- Floor or table mounted
- Suitable for wet or dry sieving
- Digital controls for easy and reliable operation via external interface
- Economical



Do not make any changes to the machine and use only spare parts and accessories approved by Endecotts Ltd.

The declaration of conformity to the European directives by Endecotts will otherwise lose its validity.

Furthermore this will result in the loss of any kind of guarantee claims.



WHEN PARTICLE SIZE MATTERS

Specifications

1. Technical specifications

Range	20 μ m to 125 mm
Drive / sieving motion	electromagnetic 3D
Max. Batch / feed capacity	6 kg
Max. Number of fractions	6 full height / 12 half height (300 mm or 12")
Amplitude	0 - 2 mm digital setting in 10 steps
Speed	3,000 min ⁻¹ at 50 Hz
Time display	digital, 0:10-99:50 min
Interval operation	yes (one mode)
Suitable for dry sieving	yes
Suitable for wet sieving	yes
Serial interface	-
Sieve diameter	100 / 150 / 200 / 250 / 300 / 315 mm or 3" / 8" / 12"
Clamping device	quick-release clamping system (included)
Model	bench top or floor standing
Protection code	IP 54
Electrical supply	different voltages available
Power connection	1 – Phase
Ø x H	427mm x 240 mm (without clamping unit)
Net weight	~ 45 kg
Standards	CE

Noise characteristic values:

Example 1:

Emission value related to workplace $L_{pAeq} = 63$ dB (A)

(Operating conditions: Material to be sieved = quartz sand, grain size < 1mm, 5 sieves Amplitude = 1.5 mm)

Example 2:

Emission value related to workplace $L_{pAeq} = 67$ dB (A)

(Operating conditions: Material to be sieved = quartz sand, grain size < 1mm, 5 sieves Amplitude = 3 mm)

1. Setting up

Controls and functions

The sieve shaker should be placed on a level surface to ensure symmetrical distribution of the sample over the sieve mesh. The surface should be rigid and robust where vibration will not cause problems.

Operators should be familiar with and fully understand the controls and indicators before operating this machine. This should be done in conjunction with the diagram below and control panel description.

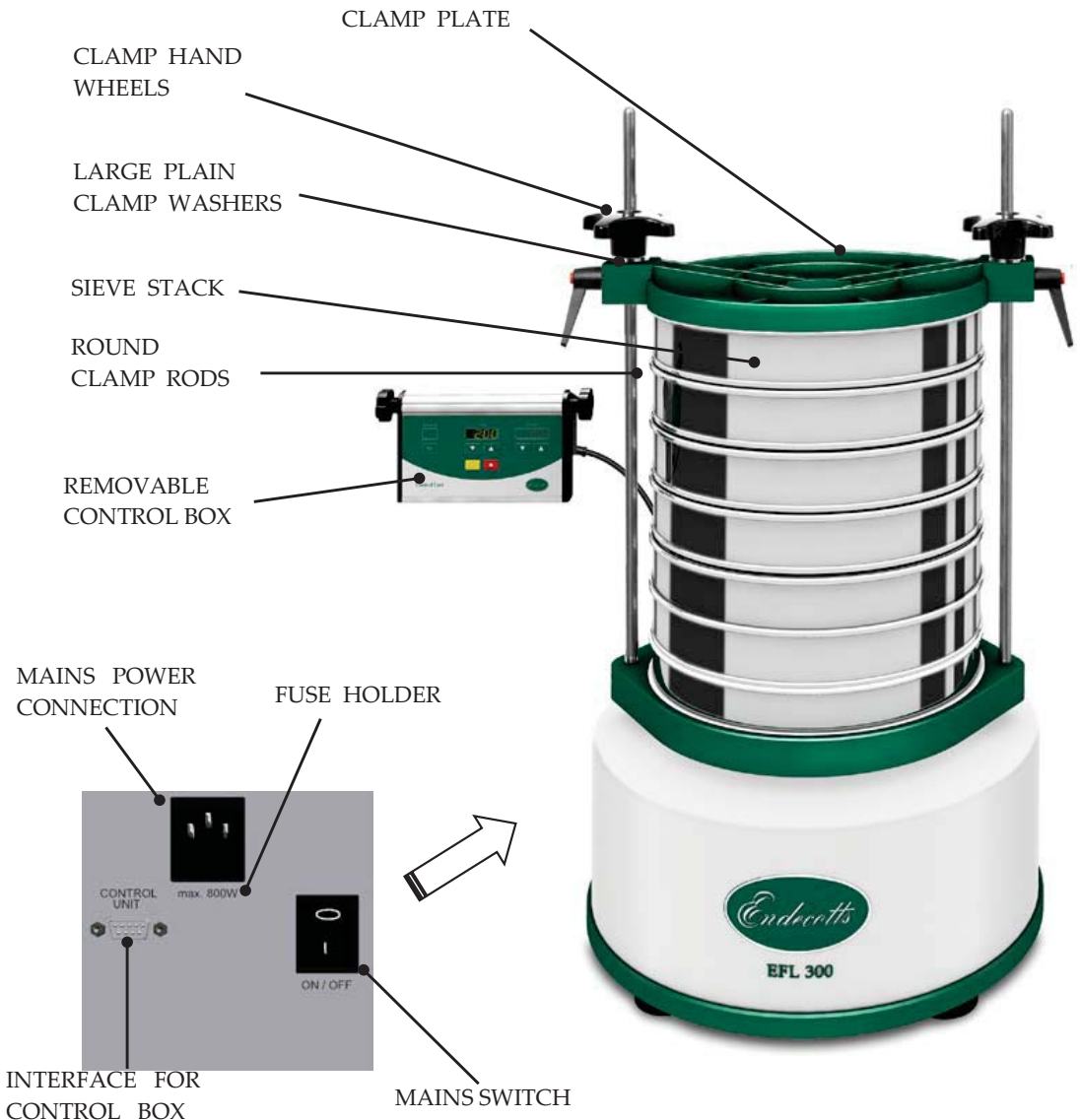

Control Box

- Connected to the machine by a 2 m serial line
- Could be mounted on the wall or placed on a table next to the machine

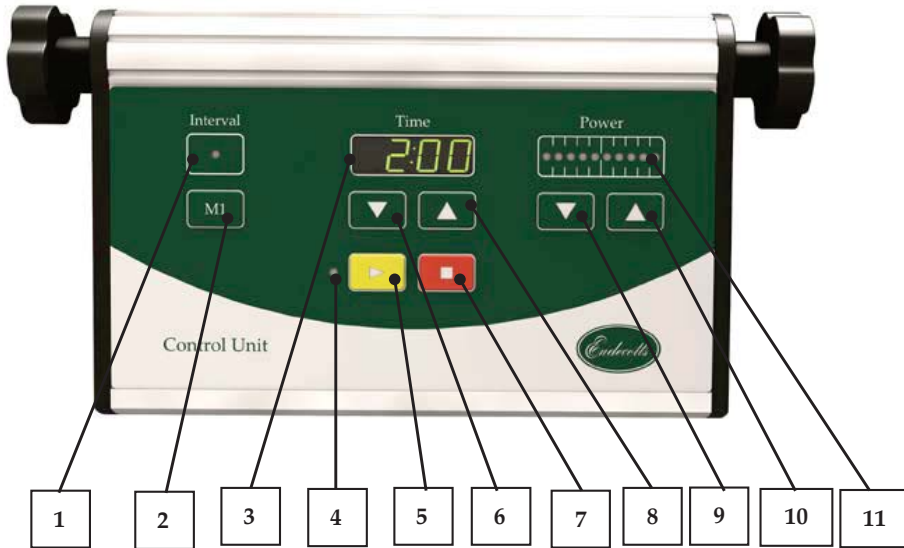

1	LED light to indicate interval operation ON.
2	Interval mode button M1 switches interval operation ON/OFF, upper LED lights up; 10 seconds on, 2 seconds off
3	Display shows the preselected sieving time, 00:10 – 99:50 min.
4	LED light to indicate START button “>” ON
5	Start the machine by pressing the START button “>”.
6 & 8	“v” and “^” button reduces/increases the sieving time, 00:10 – 99:50 min.
7	Stop the machine by pressing the STOP button “□”.
9 & 10	“v” and “^” button reduces/increases the amplitude, in 10 steps
11	10 LED’s for the Power bar indicating amplitude setting in 10 steps

Setting Up

Electrical connections

- * The voltage and frequency for the EFL 300 is given on the rating label.
- * Ensure that the values agree with the existing power supply.
- * Connect the EFL 300 to the power supply using the connection cable provided.
- * When connecting the power cable to the mains external fusing is necessary according to the regulations of the installation location



Do not connect to any other supply other than stated on the rating label, otherwise electrical and mechanical components can be damaged.

Ambient temperature: 5°C to 40°C



If the ambient temperature is exceeded or drops below the specified value the electrical and mechanical components may become damaged and the performance data can change to an unknown degree.

Atmospheric humidity:

Maximum relative humidity 80% at temperatures up to 31°C, with linear reduction down to 50% relative humidity at 40°C.



At high atmospheric humidity the electrical and mechanical components may become damaged and the performance data can change to an unknown degree.



WHEN PARTICLE SIZE MATTERS

Transport protection



Warning!

Serious personal injury

- THE APPLIANCE IS VERY HEAVY AND CAN THEREFORE CAUSE SERIOUS PERSONAL INJURIES.
- NEVER LIFT ABOVE HEAD HEIGHT.

Unscrew the screws on either side of the machine



NOTICE

The transport lock can also be used as carrying aid



You can also use the transport lock for lifting the device with a crane.

NOTICE

The housing can be damaged if the lifting straps are too short.

- Use 4 sufficiently long lifting straps.
- Observe the minimum distance between the device and the lifting gear.

IMPORTANT



If the machine is operated with the transit bolts, or is transported without transit bolts, mechanical components may become damaged.

1. Setting up

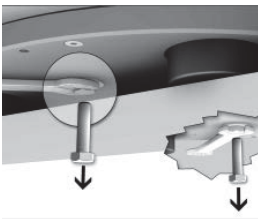
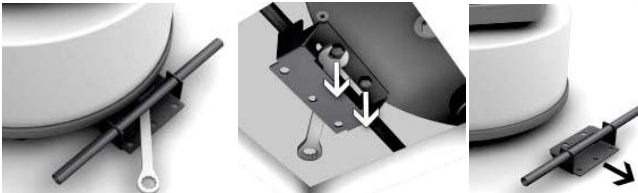

The **transit bolts** are fixed to the underneath of the device.
Use a 13 mm wrench to attach and remove the four screws.

Place the **EFL 300** on a stable floor, since otherwise unpleasant vibrations will be transmitted. Being placed on a level surface ensures symmetrical distribution of the sample over the sieves, during operation.

- Unscrew the two hexagon screws (transit bolts) on the bottom of the sieve shaker with an open ended spanner until the sieve plate is movable.
- Keep hexagon screws (transit bolts) for possible transport at a later date.

IMPORTANT



If the machine is operated with **the transit bolts**, or is transported without transit bolts, mechanical components may become damaged.

Reusing transit bolts

- Dismount the clamping unit.
- Screw the hexagon screws (transit bolts) into the two holes on the bottom of the sieve shaker and tighten with open ended spanner until the sieve plate is no longer movable.



WHEN PARTICLE SIZE MATTERS

Mount sieve clamping unit

Fit one M12 nut onto each clamp rod selected for use, then screw the pair of clamp rods into the location plate and tighten the locknuts.

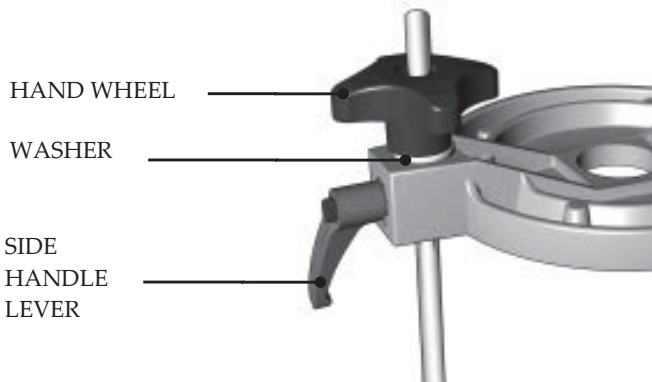
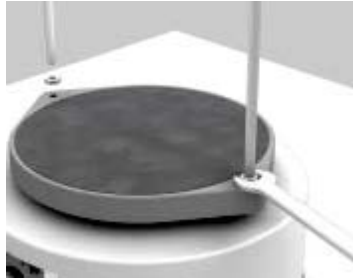

Place the two large plain washers over the 20mm threads of the clamp sleeves. These can be seen protruding vertically from the two side lugs on the clamp plate.

Screw the two hand wheels loosely onto the 20mm threads; leave a gap of 5 mm between the large washer and the hand wheel face. Do not tighten right down at this point.

Operating Instructions

1. Place the receiver centrally on the location plate in the appropriate recess.
2. Stack the required test sieves on top of the receiver (min. 1x receiver + 2x sieves + 1x lid).
3. Put the sample in the top sieve and fit the lid

In order to guarantee exact results under fast sieving conditions, the quantity of material to be sieved should be adapted to the sieve diameter and the nominal mesh size.

More detailed information is displayed in our "TEST SIEVING MANUAL".

4. Align the locking assemblies in figure 1 the two side lugs of the clamp plate with the round clamp rods. Slide the clamp plate down squarely onto the lid at the top of the sieve stack.

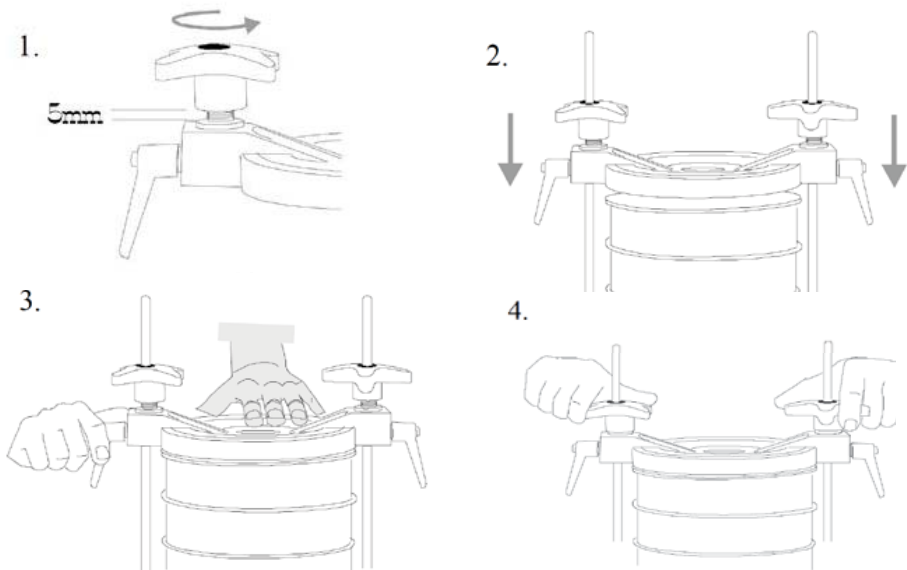

Ensure that the clamping hand wheels at the top (figure 2) are loose and the locking assemblies are fully pushed down. There should be a 5mm gap between the large plain washer and the face of the hand wheel.



WHEN PARTICLE SIZE MATTERS

1. Technical specifications

Place one hand on the top of the clamp plate (figure 3) and hold square while locking one side handle lever. Repeat for the opposite side handle lever.

The side handle levers can be set vertically downwards by pressing on the Red button and pulling the handle outwards to release (figure 4). Turn the handle to a safe, convenient angle downwards and release to engage the teeth. Screw the two clamping hand wheels down simultaneously to ensure the clamping plate is square.

Continue until the hand wheels are tight against the internal stop. Hand tightness must be exerted so that the assembly does not loosen during vibration.

The locking side handle levers and clamping hand wheels must be tightened sufficiently to ensure that the sieves and receiver are clamped securely during operation.

5. Set time and amplitude.
6. Press START



Damage may occur if the shaker is allowed to operate with a loose clamping plate.

Wet sieving

The Wet Sieving Adaptor Kit is supplied as an optional extra for 300mm or 12" diameter sieves and should be ordered separately.

The Wet Sieving Adaptor Kit consists of the following items:

- 1 off Special Wet Sieving Clamp Plate.
- 1 Set off O-ring Seals (One required for each sieve in the stack.)
- 1 off Special Wet Sieving Receiver with a spout (Specify for 300 mm or 12" diameter sieves)

The O-ring seals are fitted on to the outside of the bottom rim of each sieve, which means the sieves are stacked onto each other and they form a seal.

The bottom sieve is placed on the special receiver with a spout.

A nylon hose tail must be fitted and must have a suitable length of hose fitted to drain into a convenient drainage point.

Fit a suitable length of hose to the spout to drain into a convenient drainage point.

The clamp plate is usually supplied with the rose reversed to avoid damage. Undo and reverse, so that the rose head is on the inside. Remove the lid from the sieve stack and replace the standard clamp plate with the wet sieving clamp plate. Fit a suitable length of hose to the inlet of the rose on the clamp plate and connect to the fluid supply with flow regulation.



Never operate your **Sieve shaker** directly in water.
Danger through current surge.



During wet sieving always operate your **Sieve shaker** connected to a mains socket protected by an FI protective (safety) switch.



The water quantity added should always be dosed in such a way that the sieve surface is only just wetted.



WHEN PARTICLE SIZE MATTERS



WHEN PARTICLE SIZE MATTERS

CERTIFICATE OF CE-CONFORMITY
ANALYTICAL SIEVE SHAKER
EFL 300

Certificate of CE-Conformity according to:

EC Mechanical Engineering Directive 2006/42/EC

Applied harmonized standards, in particular:
EN ISO 12100 Security of machines

EC Directive Electromagnetic Compatibility 2004/108/EC

Applied standards, in particular:

EN55011:2009+A1:2010, Group 1, Class B Radio disturbance characteristics –
Limits and methods of measurement

EN 61000-3-2:2006+A1:2009+A2:2009
EN 61000-3-3:2008
EN61326-1:2006

Additional applied standards, in particular

EN 61010 Safety prescriptions concerning measuring, operating, controlling and laboratory equipment

Authorised for the compilation of technical documents:

Endecotts Ltd (technical documentation)

The following records are held by Endecotts Ltd in the form of Technical Documentation:

Detailed records of engineering development, construction plans, study (analysis) of the measures required for conformity assurance, analysis of the residual risks involved and operating instructions in due form according to the approved regulations for preparation of user information data.

The CE-conformity of the Endecotts Analytical Sieve Shaker Type EFL300 is assured herewith.

In case of a modification to the machine not previously agreed with us as well as the use of not licensed spare parts and accessories this certificate will lose its validity.

Endecotts Ltd

London, June 2015

